

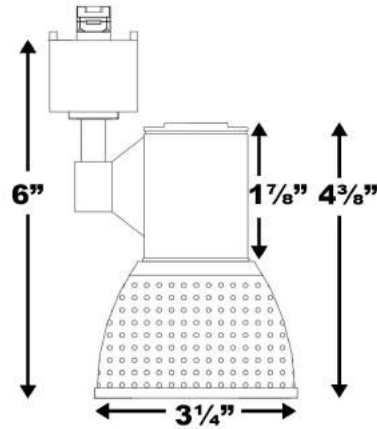

<u>PROJECT</u>
<u>CONTACT (NAME/TEL)</u>

Line Voltage Track Lighting Fixture 50139



PRODUCT DESCRIPTION

- 350° horizontal rotation or 90° vertical projecting.
- Accepts PAR20 lamp up to 50 watts.

SPECIFICATIONS

Description	Line Voltage Track Lighting Fixture
Wattage	50W (max)
Voltage	120V
Lamp Type	PAR20 Halogen / LED Light Bulb (Not Included)
Finish	Black (BK), White (WH), Brushed Steel (BS), Dark Bronze (DB), Rust (RU).
Environment	Indoor, Dry Location.
Rating	UL &cUL Listed

Ordering Information

System	Model	Watt	Finish
HT*, HT2, JT	50139	50	BK / WH / BS / DB / RU

*"Pull-up" contact to up position for two-circuit application

Ordering Examples: HT-50139-WH-WH, HT-50139-BK-BS, JT-50139-BK-BK

Product specification subject to change without notice.